

Available in 4 locking nose orientations

- 12H->R197.160.-28
- 3H->R197.160.-35
- 6H->R197.160.-34
- 9H->R197.160.-32

Replace - by coding letter for complete part number

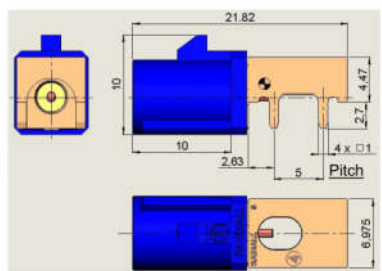
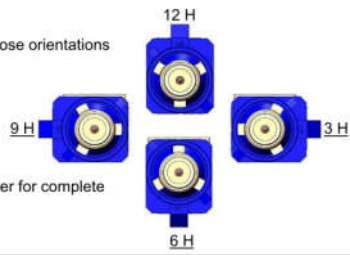

9 codings for 4 locking nose orientations available : coding A B C D E G H I K (additional coding on request)



Tape & reel packaging: 350 pcs

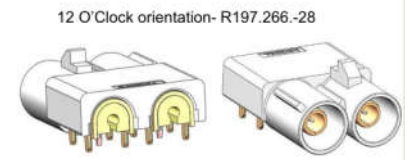

Prototype available in 2013- serial part will be develop on customer firm order

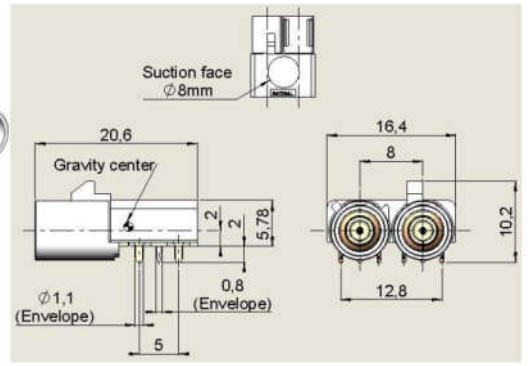

Tape & reel packaging: 250 pcs

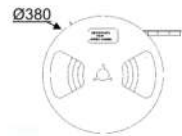

Available in 4 locking nose orientations

- 12H->R197.166.-28
- 3H->R197.166.-25
- 6H->R197.166.-24
- 9H->R197.166.-22

Replace - by coding letter for complete part number

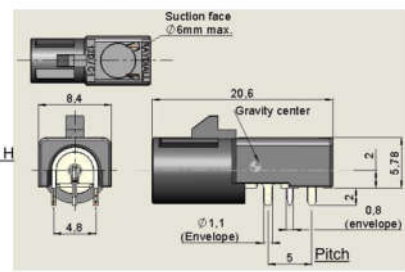
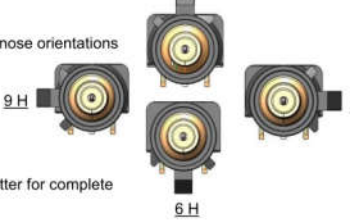

8 codings for 4 locking nose orientations (additional coding on request)



Tape & reel packaging: 400 pcs

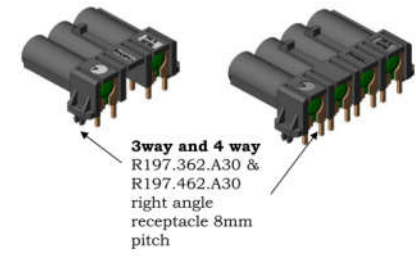
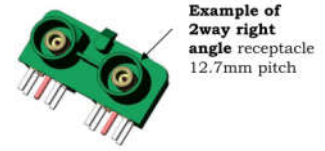
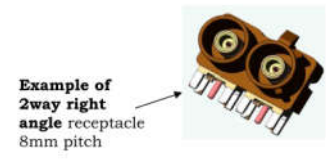

2 way and 4 way right angle custom designed receptacle 8mm pitch with panel grounding

